









## Pole

<b>Code article</b>	<b>86.OF11.4451.02</b>
<b>Type de produit</b>	<b>Extérieur</b>
<b>Catégorie</b>	<b>Industriel</b>
<b>Famille</b>	<b>COURT</b>
<b>Sous-famille</b>	<b>Pole</b>
<b>Pictograms</b>	      

## Dessin technique

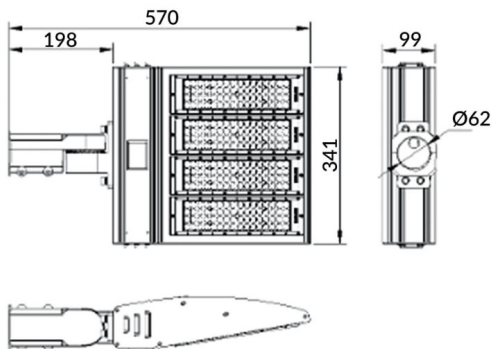

<b>Produit</b>	
<b>Puissance système (W)</b>	<b>200</b>
<b>Flux lumineux utile (lm)</b>	<b>28000</b>
<b>Efficacité lumineuse (lm/W)</b>	<b>140</b>
<b>Angle de faisceau</b>	<b>50x90</b>
<b>IP</b>	<b>IP65</b>
<b>Équipement</b>	<b>ON-OFF</b>
<b>Durée de vie utile (h)</b>	<b>Up to 100,000hrs LM70</b>
<b>Température de couleur (K)</b>	<b>5000K</b>
<b>Uniformité chromatique (SDCM)</b>	<b>5</b>
<b>CRI</b>	<b>75</b>
<b>IK</b>	<b>IK10</b>